

# WATER DISPENSER

Model:  
35AN  
45AS  
45A red

**HotFrost**  
*We Sell Climate*

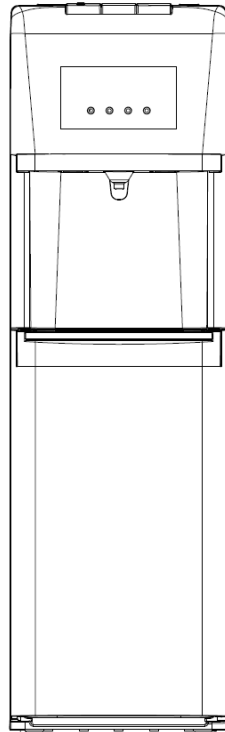

Please read the manual carefully before operating your water dispenser. Retain it for future reference.

## USER MANUAL

## A: PART NAME

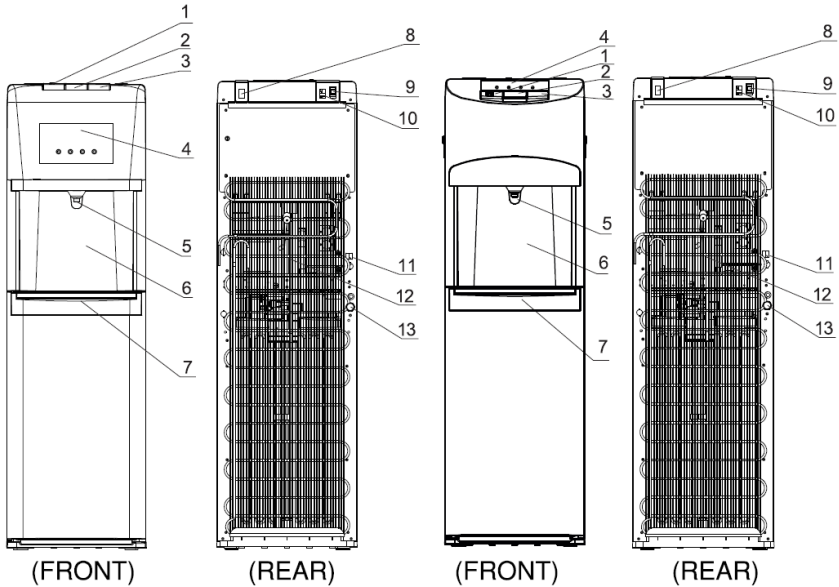

35AN

45AS / 45A red

NO.	PART NAME	NO.	PART NAME
1	push button of hot water	8	LED night light switch
2	push button of normal water	9	heating switch
3	push button of cold water	10	cooling switch
4	panel	11	power cord
5	spout	12	condenser
6	front carapace	13	outlet of hot water
7	water collector		

### NOTE:

This machine can be suitable for bottle of 3 or 5 gallons. Don't use unhealthy hard water .

## B: SAFETY PRECAUTIONS

### WARNING

**To reduce risk of injury and property damage, user must read this entire guide before assembling, installing & operating dispenser.**

**Failure to execute the instructions in this manual can cause personal injury or property damage.**

**This product dispenses water at very high temperatures. Failure to use properly can cause personal injury.**

**When operating this dispenser, always exercise basic safety precautions, including the following:**

- Prior to use, this dispenser must be properly assembled and installed in accordance with this manual.
- This dispenser is intended for water dispensing only. Do NOT use other liquids. Do NOT use for other purposes. Never use any other liquid in the dispenser other than known and microbiologically safe bottled water.
- For indoor use only. Keep water dispenser in a dry place away from direct sunlight. Do NOT use outdoors.
- Install and use only on a hard, flat and level surface.
- Do NOT place dispenser into an enclosed space or cabinet.
- Do NOT operate dispenser in the presence of explosive fumes.
- Position back of dispenser no closer than 4 inches from wall and permit free airflow between wall and dispenser. There must be at least 20cm clearance on the sides of the dispenser to permit airflow.
- Use only properly grounded outlets.
- Do not use an extension cord with your water dispenser.
- Always grasp plug and pull straight out from outlet. Never unplug by pulling on power cord.
- Do NOT use dispenser if cord becomes frayed or otherwise damaged.
- To protect against electric shock, do NOT immerse cord, plug, or any other part of dispenser in water or other liquids.
- Ensure dispenser is unplugged prior to cleaning.
- Never allow children to dispense hot water without proper and direct supervision. Unplug unit to prevent unsupervised use by children.
- Service should be performed only by a certified technician.
- Warning: Do not damage the refrigerant circuit.

- This appliance can be used by children aged from 8 years and above if they have been given supervision or instruction concerning use of the appliance in a safe way and if they understand the hazards involved. Physical defects or people with disabilities should be accompanied by a guardian with using it. Cleaning and user maintenance shall not be made by children unless they are older than 8 and supervised. Keep the appliance and its cord out of reach of children aged less than 8 years.
- Appliances can be used by persons with reduced physical, sensory or mental capabilities or lack of experience and knowledge if they have been given supervision or instruction concerning use of the appliance in a safe way and understand the hazards involved.
- This appliance is intended to be used in household and similar applications such as: Staff kitchen areas in shops, offices and other working environments. Farm houses and by clients in hotels, motels and other residential type environments. Bed and breakfast type environments. Catering and similar non-retail applications.
- Do not store explosive substances such as aerosol cans with a flammable propellant in this appliance.
- **WARNING!** To avoid a hazard due to instability of the appliance, it must be fixed in accordance with the instructions.
- If the supply cord is damaged, it must be replaced by the manufacturer, its service agent or similarly qualified persons in order to avoid a hazard. Never turn the machine upside down or lean it more than 45°
- When the machine is under the ice point and blocked by ice, the cooling switch must be closed for 4 hours before turning it on again to continue its operation.
- This machine should not be turned on until 3 minutes later after turning off the power switch.

## C: GETTING STARTED

### Locate Dispenser

1. Place dispenser upright.
2. Locate dispenser on a hard and level surface in a cool shaded location near a grounded wall outlet.

**Notice: Do NOT plug in power cord yet.**

3. Position dispenser so the back is at least 20cm from wall and there are at least 20cm of clearance on both sides.

### Assemble

1. Remove drip tray from door and place the grid on top.
2. Snap drip tray and grid assembly into door.

## Install Water Bottle

1. Open dispenser door.
2. Place probe assembly on probe hanger.
3. Place fresh bottle outside of cabinet.
4. Remove entire plastic cap from top of bottle.
5. Clean outside of new bottle with a cloth.
6. Place probe into bottle.
7. Slide collar down until it clicks in place.
8. Push head down until tubes hit bottom of bottle.
9. Slide bottle into cabinet and close door.

## Provide Electricity

Plug cord into a properly grounded wall outlet.

At this time the pump will begin to move water from the bottle to the hot and cold tanks. It will take up to 12 minutes to fill the tanks for the first time. During this period the pump will run continuously. This is normal.

## Activate Heating & Cooling

**Notice: This unit will not dispense hot or cold water until the switches are activated.**

To activate, push top side of power switches in to start heating and cooling water.

- If you do not want to heat water, push bottom side of red switch in.
- If you do not want to cool water, push bottom side of green switch in.

## Activate Nightlight

Push top side of blue power switch in to turn light on. Push bottom side in to turn light off.

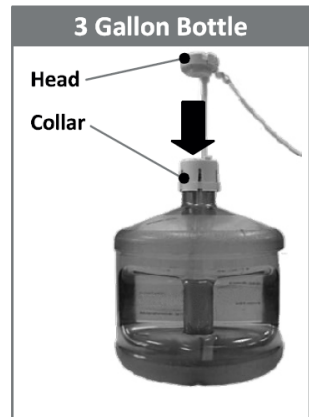
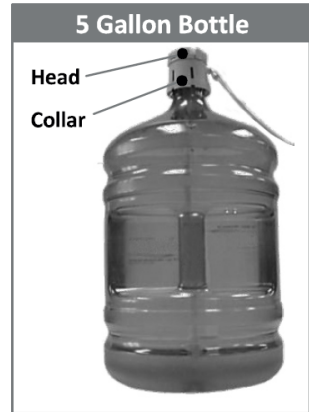

## D: DISPENSING WATER

This unit has been tested and sanitized prior to packing and shipping. During transit dust and odors can accumulate in the tank and lines. Dispense and dispose at least one quart of water prior to drinking any water.

### Dispensing Cold Water

After setup, it will take up to 1 hour to get water to maximum cold temperature. During this time the compressor could run continuously. This is normal.

1. Position bottle, glass, pitcher or cooking pot below spout.
2. Depress cold water control downward to start cold water flow.
3. Release control once desired fill level is achieved.

### Dispensing Cool Water

1. Position bottle, glass, pitcher or cooking pot below spout.
2. Depress cool water control downward to start cool water flow.
3. Release control once desired fill level is achieved.

### Dispensing Hot Water

After setup, hot water will be available in 15-20 minutes.

1. Position bottle, glass, pitcher or cooking pot below spout.
2. Slide red button away from you and depress hot water control downward to start hot water flow.
3. Release control once desired fill level is achieved.

### Changing Bottles

A flashing red light on your function lights alerts you when your bottle is empty. Replace the bottle as soon as possible.

**Notice: Do not dispense hot, cool or cold water if the red light is flashing as you could empty the tanks and cause the dispenser to overheat.**

1. Open dispenser door.
2. Slide empty bottle out of cabinet.
3. Remove probe assembly from empty bottle. Place probe assembly on probe hanger.
4. Set empty bottle aside.
5. Place fresh bottle outside of cabinet. Remove entire plastic cap from top of bottle. Clean outside of new bottle with a cloth.
6. Place probe into bottle. Slide collar down until it clicks in place. Push head down until tubes hit bottom of bottle.
7. Slide bottle into cabinet and close door.

## E: TROUBLE SHOOTING

### **Water is leaking.**

- Unplug dispenser, remove bottle and replace it .

### **No water is coming from the spout.**

- Make sure the bottle is not empty. If empty, replace it.
- Make sure to completely depress the pushbutton controls.

### **Cold water is not cold.**

- It takes up to one hour after setup to dispense cold water.
- Make sure the power cord is properly connected to a working outlet.
- Make sure the back of the dispenser is at least 20cm from a wall and there is free airflow on all 20cm sides of the dispenser.
- Make sure green power switch on back of dispenser is ON.
- If water still isn't cold, please ask for the service agent for assistance.

### **Hot water is not hot.**

- It takes 15-20 minutes after setup to dispense hot water.
- Make sure the power cord is properly connected to a working outlet.
- Make sure red power switch on back of dispenser is ON.

### **Nightlight Isn't Working**

- Make sure the power cord is properly connected to a working outlet.
- Make sure nightlight power switch on back of dispenser is ON.

### **Dispenser Is Noisy**

- Make sure the dispenser is positioned on a level surface.

## F: CLEANING

**To avoid accident, cut off the power supply before operation according to the following instruction.**

1. The machine had been disinfected before departed from factory.  
Cleaning the dispenser prior to installing a full bottle of water for the first time.
2. **Cleaning and draining instruction:**
  - 1) Making sure the power switch in the O(off) position and unplug the water dispenser before cleaning.
  - 2) Twist out the two screws ①, then take down top cover, cold tank cover and separator ②.
  - 3) Fill 0.6 gallons pure water into cold tank to clean it.
  - 4) Place a large water bucket beneath the drain outlet which on the back of water dispenser, then, remove the drain cover and drain the water ③.
  - 5) Reposition the drain cover, separator, cold tank cover and top cover after draining. Ensure the pipe and wires are connected properly, then, you can use the machine normally.

Attention: 1)The cleaning must be under the guidance of professional staff.

2)The dispenser heats water to a temperature of approximately 82°C.It can cause severe burns.Please operate it carefully.

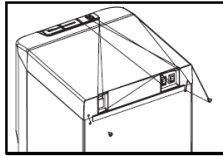

①

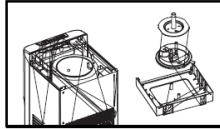

②

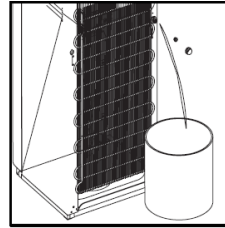

③

### 3. Sanitizing

The machine should be disinfected with the disinfectant separately bought from drugstore or marketplace according to the instruction manual of the disinfectant and then clean it with water(see **cleaning and draining instruction**).Generally this should be done every three months.

### 4. To Remove Mineral Deposits:

Mix 4 liters water with 200g citric acid crystals, inject into the machine and make sure the water can flow out of the hot water tap. Switch on the power and heat it about 10 minutes, 30 minutes later, drain off the liquor and clean it with water for two or three times. Generally this should be done every six months.

Never disassemble this machine by yourself to avoid danger from damaging machine.

## G:MACHINE INSTALLATION

To prevent the machine from swaying to fall, please install the bracket accordingly.

- 1-2. Loosen the screw of the left or right bottom angle just as the picture shown.
3. Use the screw to fix the bracket on the left or right bottom angle of the water dispenser.
4. Make a hole on the floor's or the desk's surface where the water dispenser will be installed.
5. Fix the bracket on the floor by screw tightly.
6. Tighten the screw.

